

Characterization and Analysis of Multi-Hop Wireless MIMO Network Throughput*

Bechir Hamdaoui
EECS Dept., University of Michigan
2260 Hayward Ave, Ann Arbor, Michigan, USA
hamdaoui@eecs.umich.edu

Kang G. Shin
EECS Dept., University of Michigan
2260 Hayward Ave, Ann Arbor, Michigan, USA
kgshin@eecs.umich.edu

ABSTRACT

Use of multiple antennas or MIMO has great potential for enhancing the throughput of multi-hop wireless networks via spatial reuse and/or spatial division multiplexing. In this paper, we characterize and analyze the maximum achievable throughput in multi-hop wireless MIMO networks under three MIMO protocols, *spatial reuse only* (SRP), *spatial multiplexing only* (SMP), and *spatial reuse & multiplexing* (SRMP), each of which enhances throughput via a different way of exploiting the MIMO's potential. We show via extensive simulation that as the number of antennas increases, the maximum achievable throughput first rises and then flattens out asymptotically under SRP, while it increases "almost" linearly under SMP or SRMP. We evaluate the effects of several network parameters on this achievable throughput. We also demonstrate how these results can be used by designers to determine the optimal parameters of multi-hop wireless MIMO networks.

Categories and Subject Descriptors: I.6.6 [Simulation and Modeling]: Simulation Output Analysis

General Terms: Performance, Design

Keywords: Network throughput analysis, MIMO systems, multi-hop wireless networks, wireless mesh networks

1. INTRODUCTION

Multiple antennas, also referred to as MIMO (multiple-input-multiple-output), provide wireless networks with potential for increasing network throughput via *spatial reuse* of the spectrum by allowing multiple simultaneous communication sessions in the same neighborhood and/or via *spatial division multiplexing* by achieving high data rates. For this reason, MIMO systems are expected to be a key component of next-generation wireless networks.

From the physical layer's standpoint, the potential benefits of multiple antennas are already well-understood [1–5]. How to realize these benefits at higher layers has also been studied recently [6–11]. These studies focused on the development of MAC protocols for wireless networks that exploit multiple antennas to increase the overall network throughput via spatial reuse [10, 11] and/or spatial multiplexing [7], or reduce power consumption via beam-forming

*The work reported here was supported in part by NSF under Grant No. CNS 0519498 and Intel Corporation.

Permission to make digital or hard copies of all or part of this work for personal or classroom use is granted without fee provided that copies are not made or distributed for profit or commercial advantage and that copies bear this notice and the full citation on the first page. To copy otherwise, to republish, to post on servers or to redistribute to lists, requires prior specific permission and/or a fee.

MobiHoc'07, September 9–14, 2007, Montréal, Québec, Canada.

Copyright 2007 ACM 978-1-59593-684-4/07/0009 ...\$5.00.

and interference suppression [6]. However, how much throughput multiple antennas can offer multi-hop wireless networks has been studied much less [12]. Yi *et al.* [12] extended the work in [13] to wireless networks using directional antennas. The focus in [12] is, however, on the switched multi-beam technique. Albeit simple, the switched multi-beam technique works only in a near line-of-sight environment, and may increase the capacity only through spatial reuse. In this paper, we characterize and analyze the maximum achievable throughput in multi-hop wireless MIMO networks when the adaptive array technique is used. Unlike the switched multi-beam technique, the adaptive array technique can exploit multiple antennas to increase the capacity in both line-of-sight and multipath environments [14] via not only spatial reuse but also spatial multiplexing.

The main contributions of this paper are summarized as follows.

1. Modeling of the interference and radio constraints on multi-hop wireless MIMO networks under the three MIMO protocols and two interference avoidance models we propose.
2. Characterization and analysis of the maximum achievable throughput in multi-hop wireless MIMO networks. Via extensive simulations, we show that as the number of antennas increases, the maximum achievable throughput flattens out asymptotically under SRP and increases "almost" linearly under SMP or SRMP.
3. Evaluation of the effects of several network parameters on this achievable throughput. We also demonstrate practical use of the obtained results by illustrating how they can be used by network designers to determine the optimal parameters of multi-hop wireless MIMO networks.

The rest of this paper is organized as follows. Section 2 discusses the related work, putting our work in a comparative perspective. Section 3 overviews MIMO and illustrates its potential benefits. We model the network under study and state our objectives in Section 4. Section 5 models the packet-level constraints, while Section 6 formulates the multi-commodity flow routing problem. Throughput characterization and analysis are provided in Section 7. Finally, we conclude the paper in Section 8.

2. RELATED WORK

There have been numerous studies on throughput/capacity characterization of wireless networks equipped with single antennas [13, 15–18]. Gupta and Kumar [13] derived the asymptotic capacity of multi-hop wireless networks of static nodes, each equipped with a single omnidirectional antenna. The work in [15] shows that per-user throughput can increase dramatically when nodes are mobile rather than fixed by exploiting a form of multiuser diversity via

packet relaying. Several other studies have also focused on characterizing the capacity in multi-channel wireless networks [16–18]. The work in [13] has been extended in [16] to multi-channel wireless networks where nodes, each equipped with multiple interfaces, cannot have a dedicated interface per channel. Their results show that the capacity of such networks depends on the ratio of the number of channels to the number of interfaces. Alicherry *et al.* [17] developed a solution for routing in multi-channel, multi-interface wireless mesh networks that maximizes the overall throughput of the network subject to fairness and interference constraints. Along the same line, the work in [18] provides necessary conditions for the feasibility of rate vectors in multi-channel wireless networks with multiple interfaces, and use them to find upper bounds on throughput via a fast primal-dual LP algorithm. We adapt the LP constraint relaxation technique from [18] to characterize the maximum achievable throughput in multi-hop wireless networks of nodes equipped with MIMO links.

3. PRELIMINARIES: MIMO LINKS

The term *MIMO link* is used to denote any transmitter-receiver pair such that (1) the receiver is within the transmitter’s transmission range, and (2) both the transmitter and receiver are equipped with multiple antennas.

3.1 Basics of MIMO

Let’s consider the MIMO link shown in Fig. 1(a), and assume that the transmitter and the receiver are each equipped with 2 antennas. To transmit a signal $s(t)$ over the 2-antenna array, the transmitter sends two weighted copies, $u_1 s(t)$ and $u_2 s(t)$, of the signal, one on each antenna; the vector¹ $\mathbf{u} = [u_1 \ u_2]^T$ is referred to as a *transmission weight vector*. At the receiver, the two received signals (one on each antenna) are weighted with a *reception weight vector* $\mathbf{v} = [v_1 \ v_2]^T$ and summed to produce $r(t)$. This is illustrated in Fig. 1(b). Let \mathbf{H} denote the matrix of channel coefficients between the transmitter and the receiver. One can then write $r(t) = (\mathbf{u}^T \mathbf{H} \mathbf{v}) s(t)$. By choosing appropriate weight vectors \mathbf{u} and \mathbf{v} , one can ensure that the signal $r(t)$ achieves a unit gain ($\mathbf{u}^T \mathbf{H} \mathbf{v} = 1$) when received by the target receiver, and a zero gain ($\mathbf{u}^T \mathbf{H} \mathbf{v} = 0$) when received by a non-target receiver. Hence, with multiple antennas, a node can successfully communicate with its target receiver while allowing other nearby receivers to successfully receive their signals.

Multiple antennas can also be exploited to send multiple-stream signals. As shown in Fig. 1(c), the transmitter can send two streams, $s_1(t)$ and $s_2(t)$, each weighted over both antennas using the transmission weight vectors $\mathbf{u}_1 = [u_{1,1} \ u_{1,2}]^T$ and $\mathbf{u}_2 = [u_{2,1} \ u_{2,2}]^T$, respectively. At the receiver, two separate streams, $r_1(t)$ and $r_2(t)$, are constructed by weighting the two received signals (one on each antenna) by two reception weight vectors $\mathbf{v}_1 = [v_{1,1} \ v_{1,2}]^T$ and $\mathbf{v}_2 = [v_{2,1} \ v_{2,2}]^T$. One can write $r_1(t) = (\mathbf{u}_1^T \mathbf{H} \mathbf{v}_1) s_1(t) + (\mathbf{u}_2^T \mathbf{H} \mathbf{v}_1) s_2(t)$ and $r_2(t) = (\mathbf{u}_1^T \mathbf{H} \mathbf{v}_2) s_1(t) + (\mathbf{u}_2^T \mathbf{H} \mathbf{v}_2) s_2(t)$. With an appropriate choice of all the weight vectors and under the assumption that \mathbf{H} is a full-ranked matrix [5], one can ensure that $\mathbf{u}_1^T \mathbf{H} \mathbf{v}_1 = 1$ and $\mathbf{u}_2^T \mathbf{H} \mathbf{v}_1 = 0$ to correctly construct $r_1(t)$, and $\mathbf{u}_1^T \mathbf{H} \mathbf{v}_2 = 0$ and $\mathbf{u}_2^T \mathbf{H} \mathbf{v}_2 = 1$ to correctly construct $r_2(t)$. Hence, multiple antennas can be exploited to *increase* the data rates by sending multiple-stream signals.

3.2 Benefits of MIMO

To illustrate MIMO benefits, let’s consider the example of a multi-hop MIMO network in Fig. 2, which consists of a set $N = \{1, 2, 3, 4\}$

¹The superscript T indicates the matrix transpose operation.

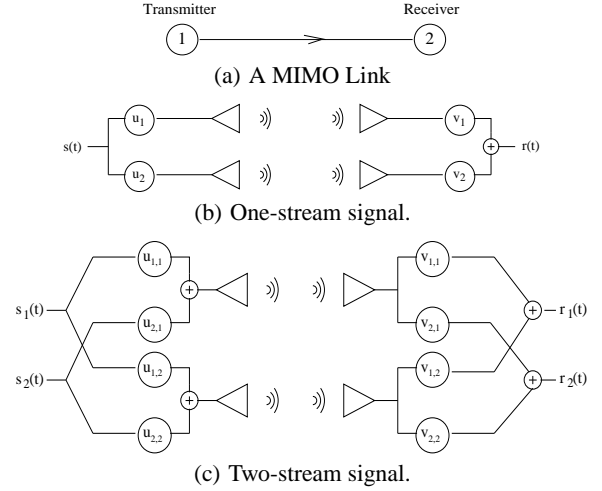

Figure 1: MIMO processing.



Figure 2: An illustrative network example.

of 4 nodes, and a set $L = \{(1, 3), (2, 4), (1, 4)\}$ of MIMO links. Suppose each node has 2 antennas ($\gamma_m = 2, \forall m \in N$).

3.2.1 Spatial Reuse

Due to multiple antennas, transmitters can null their signals at undesired nearby receivers (i.e., prevent their signals from reaching undesired nearby receivers) while ensuring acceptable signal gains at their desired receivers. Likewise, receivers can use their multiple antennas to suppress interferences caused by undesired nearby transmitters while successfully receiving their desired signals. For the purpose of illustration, let’s assume that, at a given time t , nodes 1 and 2 both decided to transmit signals to nodes 3 and 4, respectively. First, note that if nodes are equipped with single omnidirectional antennas, then node 1’s transmission will interfere with node 4’s reception, and hence, node 4 won’t be able to successfully receive the signal from node 2. Because node 4 has 2 antennas, its reception weight vector \mathbf{v}_4 can be so chosen that the interference caused by node 1’s transmission may be suppressed while assuring an acceptable gain of its intended signal from node 2. These constraints or requirements can be written as $(\mathbf{u}_2^T \mathbf{H}_{2,4}) \mathbf{v}_4 = 1$ and $(\mathbf{u}_1^T \mathbf{H}_{1,4}) \mathbf{v}_4 = 0$ where $\mathbf{u}_2 = [u_{2,1} \ u_{2,2}]^T$ is the transmission weight vector of node 2 and $\mathbf{v}_4 = [v_{4,1} \ v_{4,2}]^T$ is the reception weight vector of node 4. Knowing $\mathbf{H}_{1,4}$, $\mathbf{H}_{2,4}$, \mathbf{u}_1 , and \mathbf{u}_2 , node 4 can solve the system of these two equations to determine \mathbf{v}_4^* which can then be used to receive an interference-free signal from node 2 *concurrently* with node 1’s transmission signal. Multiple antennas can thus be exploited to *increase spatial reuse* by allowing multiple simultaneous transmissions in the same vicinity.

3.2.2 Spatial Division Multiplexing

Suppose node 1 does not transmit at time t , then node 4 can use both antennas to receive two streams of data concurrently. To design its reception weight vectors $\mathbf{v}_{4,1} = [v_{4,1,1} \ v_{4,1,2}]^T$ and $\mathbf{v}_{4,2} = [v_{4,2,1} \ v_{4,2,2}]^T$, we need to solve two systems of linear equations

$$\begin{cases} (\mathbf{u}_{2,1}^T \mathbf{H}_{2,4}) \mathbf{v}_{4,1} = 1 \\ (\mathbf{u}_{2,2}^T \mathbf{H}_{2,4}) \mathbf{v}_{4,1} = 0 \end{cases} \quad \text{and} \quad \begin{cases} (\mathbf{u}_{2,1}^T \mathbf{H}_{2,4}) \mathbf{v}_{4,2} = 0 \\ (\mathbf{u}_{2,2}^T \mathbf{H}_{2,4}) \mathbf{v}_{4,2} = 1 \end{cases}$$

where $\mathbf{u}_{2,1} = [u_{2,1,1} \ u_{2,1,2}]^T$ and $\mathbf{u}_{2,2} = [u_{2,2,1} \ u_{2,2,2}]^T$ are the

two transmission weight vectors used by node 2 to transmit its two streams. The solution can then be used by node 4 to receive two concurrent data streams from node 2. Hence, multiple antennas can also be used to increase the transmission rates by exploiting the *spatial multiplexing* offered by the antennas. Note that now, node 1 cannot transmit without causing interference at node 4; spatial reuse cannot be increased when all antennas are used for spatial multiplexing.

3.3 Interference Avoidance Models

We now propose two models² that can be used by nodes to suppress interference and/or null undesired signals so that the spatial reuse of spectrum may be increased.

Non-Cooperative Interference Avoidance Model (NiM): This model requires that (1) transmitters be responsible for nulling their signals at all nearby interfering receivers prior to transmitting their signals, and (2) receivers be responsible for suppressing the interference caused by all nearby transmitters prior to receiving their desired signals. That is, before transmitting its signal, a transmitter must ensure that it has enough antennas to transmit the signal without causing interference to any of its nearby receivers. Likewise, prior to receiving signals, a receiver must ensure that it has enough antennas to be able to suppress the interference caused by all nearby transmitters while receiving its desired signals without interference. In the example network of Fig. 2, under NiM, node 4 must then be able to suppress node 1’s signal prior to receiving node 2’s signal, and node 1 must be able to null its signal at node 4 prior to transmitting a signal to node 3.

Cooperative Interference Avoidance Model (CiM): Note that it suffices for node 4 to suppress node 1’s signal, or for node 1 to null its signal at node 4 to have two successful transmissions. Unlike NiM, CiM requires that either the transmitter or the receiver (not necessarily both) be responsible for interference avoidance. Referring to the example of Fig. 2 again, nodes 1 and 4 must then coordinate to design their vectors such that

$$\begin{cases} \mathbf{u}_1^T (\mathbf{H}_{1,3} \mathbf{v}_3) = 1 & \text{(ensured by node 1)} \\ \mathbf{u}_1^T \mathbf{H}_{1,4} \mathbf{v}_4 = 0 & \text{(ensured by either node 1 or node 4)} \\ (\mathbf{u}_2^T \mathbf{H}_{2,4}) \mathbf{v}_4 = 1 & \text{(ensured by node 4).} \end{cases}$$

Clearly, CiM provides higher spatial reuse of multiple antennas than NiM. This will be justified later.

3.4 Effective Degrees of Freedom

Based on the illustrations given in Section 3.2, one can draw the following conclusion. A node’s degrees of freedom (DoFs or number of antennas) can be exploited in one of the following three ways: (1) all DoFs are used to send a multiple-stream flow of data by exploiting the spatial division multiplexing of the antenna array; (2) all DoFs are used to increase the spatial reuse of the spectrum by allowing multiple concurrent streams in the same vicinity; (3) some of DoFs are used to send a multiple-stream flow while the others are used to allow for concurrent streams in the same neighborhood. It is important to note that the level of exploitation of the spatial reuse and/or multiplexing is, however, contingent on physical limitations such as node’s power, multipath, and/or channel coefficients estimation errors [19].

Let’s consider two neighbor nodes m and n each equipped with an antenna array of size γ_m and γ_n , respectively, and assume that m wants to transmit a χ -stream data signal to n . Suppose there are φ streams currently being received by nodes located within m ’s

²It is important to mention that we only provide key features of the models relevant to this work. Hence, we omit details on how and when nodes exchange information such as weight vectors.

transmission range, and ψ streams currently being transmitted by nodes located within n ’s reception range. Due to physical limitations, the number $(\varphi + \chi)$ of possible concurrent streams in m ’s vicinity is likely to be less than the number of its actual antenna elements γ_m [19]. We will refer to this number $\alpha_m = (\varphi + \chi)$ as *effective transmit degrees of freedom* of node m . For similar reasons, the number $(\psi + \chi)$ of possible concurrent streams in n ’s vicinity is also likely to be less than its total number of antennas γ_n [19]. This number $\beta_n = (\psi + \chi)$ will be referred to as *effective receive degrees of freedom* of node n . The authors of [20] derived a statistical method that allows each node m to determine both α_m and β_m given the network’s physical constraints. In this paper, we assume that these two numbers are known for each node.

4. PROBLEM STATEMENT

In this section, we model multi-hop wireless MIMO networks, state our objectives, and outline how to meet them.

4.1 Network Model: Assumptions & Notation

A multi-hop wireless MIMO network is modeled as a directed graph $G = (N, L)$ with a finite nonempty set N of nodes and a finite set L of MIMO links. L is the set of all ordered pairs (m, n) of distinct nodes in N such that n is within m ’s transmission range. If link $i = (m, n) \in L$, then node m and node n are referred to as the transmitter $t(i)$ and the receiver $r(i)$ of link i . A data link i is said to be *active* if $t(i)$ is currently transmitting to $r(i)$; otherwise, it is said to be *inactive*. For every $m \in N$, let $L_m^+ = \{i \in L : t(i) = m\}$ denote the set of all links whose transmitter is m , $L_m^- = \{i \in L : r(i) = m\}$ denote the set of all links whose receiver is m , and $L_m = L_m^+ \cup L_m^-$. We assume that each node m is equipped with an antenna array of γ_m elements it uses to transmit and receive signals. Let α_m and β_m denote node m ’s effective transmit and receive degrees of freedom. For every $i \in L$, let c_i denote the maximum number of bits that link i can support in one second. While c_i depends on i (i.e., could vary from link to link), it is assumed to be time-invariant.

Let C be the set of all ordered distinct pairs $(i, j) \in L \times L$ such that i and j do not share a node between them and the transmission on link i interferes with the reception on link j . Note that $(i, j) \in C$ does not necessarily imply that $(j, i) \in C$. Given a link $i \in L$, let $C_i^+ = \{j \in L : (i, j) \in C\}$ denote the set of all links whose receivers interfere with the transmission on i , and $C_i^- = \{j \in L : (j, i) \in C\}$ denote the set of all links whose transmitters interfere with the reception on i .

4.2 Objectives, Approaches, & Contributions

We want to characterize and analyze the maximum achievable throughput in multi-hop wireless MIMO networks. We propose and analyze three different MIMO protocols—spatial reuse only protocol (SRP), spatial multiplexing only protocol (SMP), and spatial reuse & multiplexing protocol (SRMP)—all of which increase network throughput, but each with a different way of exploiting the multiple antenna benefits.

Spatial Reuse Only MIMO Protocol (SRP): uses all effective degrees of freedom to increase network throughput via spatial reuse of the spectrum only. In SRP, the throughput is then increased by allowing multiple simultaneous communication sessions in the same neighborhood.

Spatial Multiplexing Only MIMO Protocol (SMP): under which all effective DoFs are used to increase throughput via spatial multiplexing only. Nodes in SMP can use their multiple antennas to communicate multiple stream signals among them. They cannot, however, use any of their effective DoFs to increase spatial reuse.

Spatial Reuse & Multiplexing MIMO Protocol (SRMP): is a combination of SRP and SMP in that the effective degrees of freedom can be used to increase network throughput via spatial reuse and/or spatial multiplexing, whichever provides higher throughput.

We consider TDMA in which time is divided into time slots of an equal length, denoted by $T = \{1, 2, \dots\}$. Characterizing the achievable throughput under TDMA will then serve as a characterization of the throughput achievable under other multiple access methods, such as CDMA and CSMA/CA.

For each MIMO protocol, we formulate the multi-hop routing problem as a standard multi-commodity flow instance that consists of a set Q of commodities where each $q \in Q$ is characterized with a source-destination pair $s(q), d(q) \in N$ and a non-negative multi-hop flow of rate f_q . A multi-hop flow solution—maximizing the sum $\sum_{q \in Q} f_q$ of all flows' rates subject to the network constraints that we will describe and model in next sections—will be used to represent the achievable throughput under multi-commodity flow $f = (f_q)_{q \in Q}$. By solving many instances, we can provide a statistical characterization and analysis of the maximum achievable throughput in multi-hop wireless MIMO networks.

Our contribution is twofold. First, we characterize and analyze the maximum achievable throughput in multi-hop wireless networks equipped with MIMO systems. We study the effects of several network parameters on this throughput. Second, we show how the thus-obtained results can be used for designing wireless MIMO networks such as MIMO mesh networks. These results enable network designers to determine the optimal parameters of wireless MIMO networks.

5. PACKET-LEVEL CONSTRAINTS

We now model the packet-level constraints on multi-hop MIMO networks, described in Section 4. $\forall (i, t) \in L \times T$, let the binary variable y_i^t be 1 if link i is active during time slot t , and 0 otherwise.

5.1 Spatial Reuse Only MIMO Protocol (SRP)

5.1.1 Radio Constraints

Due to radio limitations, we assume that a node can either transmit or receive, but not both, at a time slot. Also, since SRP exploits all degrees of freedom (DoFs) to increase spatial reuse, a node can use at most one DoF to transmit or receive one stream while the other DoFs can be used to allow for multiple concurrent streams in same vicinities. Hence, one can write

$$\sum_{i \in L_m} y_i^t \leq 1, \quad \forall m \in N, \forall t \in T. \quad (1)$$

5.1.2 Interference Constraints

Next we describe the interference constraints under both the non-cooperative interference avoidance model (NiM) and the cooperative interference avoidance model (CiM), as defined in Section 3.3.

Interference Constraints under NiM: Recall that under NiM, receivers must be responsible for suppressing signals from interfering transmitters. Hence, any receiver must have enough effective receive degrees of freedom that enable it to combat nearby transmitters' interference prior to receiving a signal at any time slot. That is, $\forall i \in L$ and $\forall t \in T$,

$$(\omega - \beta_{r(i)} + 1)y_i^t + \sum_{j \in C_i^-} y_j^t \leq \omega \quad (2)$$

where ω is an integer larger than the maximum number of active links at any given time slot. Let $\omega = |L|$. If $y_i^t = 1$ (i.e., i is active at time slot t), then the above constraints ensure that the total number of active links, interfering with the reception on link i , does not exceed what node $r(i)$'s effective receive degrees of freedom can

handle; otherwise (if $y_i^t = 0$), the constraints are relaxed since i is not active, and hence, no interference needs to be suppressed.

Likewise, transmitters under NiM must also be responsible for nulling their signals at all nearby receivers. That is, prior to transmission at any time slot, a transmitter must have enough effective transmit degrees of freedom so that it can prevent its signal from causing interference to any nearby receivers. Hence, we can write, for all $i \in L$ and all $t \in T$,

$$(\omega - \alpha_{t(i)} + 1)y_i^t + \sum_{j \in C_i^+} y_j^t \leq \omega. \quad (3)$$

Again, the above constraints ensure that the maximum number of active links interfering with the transmission on link i does not exceed what node $t(i)$ can null, i.e., no more than $\alpha_{t(i)}$ can be concurrently active at time slot t when i is active. If, however, $t(i)$ is not transmitting (i.e., $y_i^t = 0$), then the constraints are relaxed as expressed by the inequality via ω .

Interference Constraints under CiM: Under CiM, for every pair $(i, j) \in C$, one of the following two conditions must hold: the transmitter of i must null its signal at the receiver of j ; or the receiver of j must suppress the interference from the transmission on link i . Note that one (and only one) of the above two conditions needs to hold for a successful transmission on i while still receiving an interference-free signal on j . To express this set of constraints, we need to introduce two new binary variables. For every $t \in T$ and for every $(i, j) \in C$, we define binary variables

$$\lambda_{ij}^t = \begin{cases} 1 & \text{if } i \text{ and } j \text{ are both active at } t, \text{ and } t(i) \\ & \text{nulls its signal at } r(j) \\ 0 & \text{otherwise} \end{cases}$$

and binary variables

$$\mu_{ij}^t = \begin{cases} 1 & \text{if } i \text{ and } j \text{ are both active at } t, \text{ and } r(j) \\ & \text{suppresses the interference from } t(i) \\ 0 & \text{otherwise.} \end{cases}$$

The interference constraints to SRP under CiM can then be expressed as follows. For all $(i, j) \in C$ and all $t \in T$,

$$\begin{cases} 1 + \sum_{l \in C_i^+} \lambda_{il}^t \leq \alpha_{t(i)} \\ 1 + \sum_{l \in C_j^-} \mu_{lj}^t \leq \beta_{r(j)} \\ y_i^t + y_j^t \leq \lambda_{ij}^t + \mu_{ij}^t + 1. \end{cases} \quad (4)$$

5.2 Spatial Multiplexing Only MIMO Protocol (SMP)

5.2.1 Radio Constraints

Recall that SMP exploits all DoFs to increase throughput by allowing transmitter-receiver pairs to communicate multiple stream signals over their links, i.e., each transmitter-receiver pair, $(t(i), r(i))$, can communicate more than one stream over link i . Let z_i^t represent the number of streams that are active on link i at time slot t . Because the maximum number of streams communicated on link i must not exceed the effective transmit degrees of freedom of $t(i)$ nor the effective receive degrees of freedom of $r(i)$,

$$z_i^t \leq \alpha_{t(i)} y_i^t \text{ and } z_i^t \leq \beta_{r(i)} y_i^t \quad (5)$$

must hold $\forall i \in L$ and $\forall t \in T$. Like in SRP, in SMP, a node can either transmit or receive at any given time slot, and can at most be active on one link. Hence, the constraints in Eq. (1) must also hold under SMP; i.e.,

$$\sum_{i \in L_m} y_i^t \leq 1, \quad \forall m \in N, \forall t \in T. \quad (6)$$

5.2.2 Interference Constraints

Recall that all DoFs in SMP are used for spatial multiplexing, i.e., none of them are exploited to increase spatial reuse. Therefore, NiM and CiM are equivalent under SMP, and so are the interference constraints. These constraints can be written as

$$y_i^t + y_j^t \leq 1, \forall (i, j) \in C, \forall t \in T. \quad (7)$$

5.3 Spatial Reuse & Multiplexing MIMO Protocol (SRMP)

We now describe and model the packet-level constraints under SRMP. Note that the radio constraint under SRMP are equivalent to those under SMP as described in Section 5.2.1. The interference constraints, however, are different from those under SRP or SMP.

Interference Constraints under NiM: Under NiM, receivers are responsible for suppressing signals from interfering transmitters, i.e., for all $i \in L$ and all $t \in T$,

$$(\Omega - \beta_{r(i)})y_i^t + \sum_{j \in C_i^- \cup L_{r(i)}^-} z_j^t \leq \Omega \quad (8)$$

and transmitters are responsible for nulling their signals at all nearby receivers, i.e., for all $i \in L$ and all $t \in T$,

$$(\Omega - \alpha_{t(i)})y_i^t + \sum_{j \in C_i^+ \cup L_{t(i)}^+} z_j^t \leq \Omega \quad (9)$$

where Ω is an integer greater than the number of possible concurrent streams. Let $\Omega = |L| \times \max_{m \in N} \gamma_m$.

Interference Constraints under CiM: For every $(i, j) \in C$ and for every $t \in T$, we introduce two integer variables, θ_{ij}^t and ϑ_{ij}^t . θ_{ij}^t represents the number of DoFs assigned by $t(i)$ to null its signal at $r(j)$, provided both i and j are active, i.e., $r(j)$ can have up to θ_{ij}^t interference-free streams. ϑ_{ij}^t represents the number of DoFs assigned by $r(j)$ to suppress interference coming from $t(i)$, provided both i and j are active, i.e., ϑ_{ij}^t streams can be sent by $t(i)$ without causing interference at $r(j)$. The constraints under CiM can then be written as follows. $\forall (i, j) \in C$ and all $t \in T$,

$$\begin{cases} \sum_{l \in L_{t(i)}^+} z_l^t + \sum_{l \in C_i^+} \theta_{il}^t \leq \alpha_{t(i)}, \\ \sum_{l \in L_{r(j)}^-} z_l^t + \sum_{l \in C_j^-} \vartheta_{lj}^t \leq \beta_{r(j)}, \\ z_i^t \leq \vartheta_{ij}^t + \alpha_{t(i)}(1 - y_i^t), \\ z_j^t \leq \theta_{ij}^t + \beta_{r(j)}(1 - y_j^t). \end{cases} \quad (10)$$

5.4 Observations

There are two points worth mentioning regarding the above design constraints. First, they all constrain the feasibility of data transmissions on a packet-by-packet basis. That is, at every time slot, packet-level conditions must all be met in order for packet transmissions to be successful during that time slot; these constraints can then be seen as conditions under which the *instantaneous* link rates are feasible. Second, they all are necessary conditions, but not sufficient for the feasibility of packet transmissions. That is, if, at a given time slot t , some or all of these constraints are not met, then some or all of the packets transmitted at time t will be unsuccessful, whereas meeting all of these constraints does not guarantee successful transmissions of all packets.

6. MULTI-COMMODITY FLOW

6.1 LP Relaxations: Flow-Level Design

There are two subtle issues with the packet-level constraints described in Section 5. First, they are expressed in integer variables. Hence, the multi-commodity flow formulation described in Section 4.2 cannot be solved by the standard linear programming. Second, they are instantaneous, i.e., at every time slot, there is a set of

constraints that must be met. This will increase the size of the optimization problem in terms of both the number of constraints and the number of variables.

We want to provide LP relaxations of these constraints to address the above two issues. As it will become clear shortly, the relaxed constraints can be seen as necessary conditions on the feasibility of *average* link rates. Note that, by definition, LP relaxations result in widening the feasibility space; that is, the solutions obtained under the average-rate (relaxed) constraints may be infeasible under the instantaneous-rate constraints. However, since we aim to characterize the maximum achievable throughput, these relaxations will only make the maximum less tight. Clearly, there is a tradeoff between the quality of solutions and the size/complexity of problems. To keep the problem simple while drawing useful conclusions, we choose to work with the relaxed constraints instead of the packet-level ones. Next we provide LP relaxations to the packet-level constraints described in the previous section.

Let's consider a set of time slots $S \subseteq T$ of cardinality τ , and for all $i \in L$, define y_i to be $\frac{1}{\tau} \sum_{t \in S} y_i^t$. For every $(i, j) \in C$, let $\lambda_{ij} = \frac{1}{\tau} \sum_{t \in S} \lambda_{ij}^t$ and $\mu_{ij} = \frac{1}{\tau} \sum_{t \in S} \mu_{ij}^t$. Note that y_i represents the fraction of time in S during which link i is active; λ_{ij} represents the fraction of time in S during which links i and j are both active and $t(i)$ is nulling its signal at $r(j)$; and μ_{ij} represents the fraction of time in S during which links i and j are both active and $r(j)$ is suppressing the interference caused by $t(i)$'s signal.

For every $i \in L$, we also define the continuous variables z_i as $\frac{1}{\tau} \sum_{t \in S} z_i^t$, and for all $(i, j) \in C$, let $\theta_{ij} = \frac{1}{\tau} \sum_{t \in S} \theta_{ij}^t$ and $\vartheta_{ij} = \frac{1}{\tau} \sum_{t \in S} \vartheta_{ij}^t$. Suppose that $i, j \in L$ are both active during S . Here, z_i represents the average number of streams that are active on link i during S ; θ_{ij} represents the average number of effective transmit degrees of freedom that $t(i)$ allocates to null its signal at $r(j)$; and ϑ_{ij} represents the average number of effective receive degrees of freedom that $r(j)$ allocates to suppress the interference coming from $t(i)$. Recall that all these continuous variables are *averages* over the length of the time slot set S . Hence, the longer S is, the more accurate these averages are. We assume that S is long enough for these variables to reflect accurate averages.

By using these continuous variables, one can provide LP relaxations to the packet-level constraints described in Section 5. For example, by summing both sides of Eq. (1) over S and interchanging summations between i and t , one can obtain $\sum_{i \in L_m} y_i \leq 1, \forall m \in N$. Likewise, one can obtain LP relaxations of all the packet-level (or instantaneous) constraints described in Section 5. For convenience, we summarize all the obtained LP relaxation constraints in Table 1 (under SRP), Table 2 (under SMP), and Table 3 (under SRMP).

Table 1: LP relaxation constraints under SRP

SRP/Radio:	$\sum_{i \in L_m} y_i \leq 1, \forall m \in N$	
SRP/NiM:	$(\omega - \beta_{r(i)} + 1)y_i + \sum_{j \in C_i^-} y_j \leq \omega,$ $(\omega - \alpha_{t(i)} + 1)y_i + \sum_{j \in C_i^+} y_j \leq \omega,$	} $\forall i \in L$
SRP/CiM:	$1 + \sum_{l \in C_i^+} \lambda_{il} \leq \alpha_{t(i)},$ $1 + \sum_{l \in C_j^-} \mu_{lj} \leq \beta_{r(j)},$ $y_i + y_j \leq \lambda_{ij} + \mu_{ij} + 1,$	

6.2 LP Formulation

Let's consider a multi-hop wireless MIMO network routing instance that consists of a set Q of commodities, and let x_i^q denote link i 's data rate that belongs to commodity q . Note that the flow-

Table 2: LP relaxation constraints under SMP

$\sum_{i \in L_m} y_i \leq 1, \forall m \in N$	
SMP/Radio:	$\left. \begin{array}{l} z_i \leq \alpha_{t(i)} y_i, \\ z_i \leq \beta_{r(i)} y_i, \end{array} \right\} \forall i \in L$
$y_i + y_j \leq 1, \forall (i, j) \in C$	

Table 3: LP relaxation constraints under SRMP

$\sum_{i \in L_m} y_i \leq 1, \forall m \in N$	
SRMP/Radio:	$\left. \begin{array}{l} z_i \leq \alpha_{t(i)} y_i, \\ z_i \leq \beta_{r(i)} y_i, \end{array} \right\} \forall i \in L$
SRMP/NiM:	$\left. \begin{array}{l} (\Omega - \beta_{r(i)}) y_i + \sum_{j \in C_i^- \cup L_{r(i)}^-} z_j \leq \Omega, \\ (\Omega - \alpha_{t(i)}) y_i + \sum_{j \in C_i^+ \cup L_{t(i)}^+} z_j \leq \Omega, \end{array} \right\} \forall i \in L$
SRMP/CiM:	$\left. \begin{array}{l} \sum_{l \in L_{t(i)}^+} z_l + \sum_{l \in C_i^+} \theta_{il} \leq \alpha_{t(i)}, \\ \sum_{l \in L_{r(j)}^-} z_l + \sum_{l \in C_j^-} \vartheta_{lj} \leq \beta_{r(j)}, \\ z_i \leq \vartheta_{ij} + \alpha_{t(i)} (1 - y_i), \\ z_j \leq \theta_{ij} + \beta_{r(j)} (1 - y_j). \end{array} \right\} \forall (i, j) \in C$

balance constraints,

$$\sum_{j \in L_{t(i)}^+} x_j^q = \begin{cases} f_q & \text{if } t(i) = s(q) \\ \sum_{j \in L_{t(i)}^-} x_j^q & \text{Otherwise,} \end{cases} \quad (11)$$

must be satisfied for all $q \in Q$ and all $i \in L$. By letting

$$\frac{1}{c_i} \sum_{q \in Q} x_i^q = \begin{cases} y_i & \text{if under SRP} \\ z_i & \text{if under SMP or SRMP} \end{cases} \quad (12)$$

for all $i \in L$, the multi-hop wireless MIMO network routing problem can be formulated as a standard LP whose objective is to maximize $\sum_{q \in Q} f_q$ subject to the flow-balance constraints given in Eqs. (11) and (12), and the radio and interference constraints given in Table 1 (under SRP), Table 2 (under SMP), or Table 3 (under SRMP).

7. THROUGHPUT CHARACTERIZATION AND ANALYSIS

Using extensive simulations, we characterize and analyze achievable throughput in multi-hop wireless MIMO networks under the three MIMO protocols (SRP, SMP, and SRMP), and for the two interference avoidance models (NiM and CiM). Simulations are run until the measured throughput converges to within 5% of real values at a 98% confidence level.

7.1 The Simulation Method and Scenarios

We generate random multi-hop wireless MIMO networks, each consisting of N nodes. The medium's capacity, defined to be the maximum number of bits that a node with one antenna can transmit in one second, is set to unity ($c_i = 1, \forall i \in L$). All nodes are equipped with the same number of antennas. We assume that all effective degrees of freedom are equal to the number of antennas ($\alpha_m = \beta_m = \gamma_m, \forall m \in N$). Nodes are uniformly distributed in a $100m \times 100m$ square where two nodes are considered neighbors if the distance between them does not exceed TxRange me-

ters. For each random network, Q source-destination pairs are randomly generated to form Q end-to-end multi-hop commodity flows. Each LP formulation (SRP/NiM, SRP/CiM, SMP/NiM, SMP/CiM, SRMP/NiM, and SRMP/CiM), defined in Section 6, is solved for each network to find the maximum achievable throughput.

We study the effects of the following network parameters:

- 1. Transmission range (TxRange):** Recall that the higher the transmission range, the greater the interference, but also the higher the node degree. Typically, a higher interference results in less throughput, while a higher node degree yields more throughput. Here, we want to see if this trend holds even when nodes are equipped with MIMO links, and if so, to what extent it does. In this study, we fix N to 50 and Q to 25, and vary TxRange from $16m$ to $32m$.
- 2. Node density (NodeDensity):** Like the transmission range case, the higher the node density, the greater the node degree, and hence, the higher the throughput (provided other network parameters are kept the same). Unlike the transmission range case, increasing the node density while keeping the same number of commodities does not, however, raise interference levels. In this study, we want to see how sensitive throughput is to node density when MIMO sizes are varied. Here, we fix TxRange to 30 and Q to 10, and vary NodeDensity from 0.2% to 0.5% (by varying N from 20 to 50).
- 3. Multi-hop length (HopLength):** So far, Q source-destination pairs are generated randomly, and hence, so are their hop lengths (avg. hop length varied between 2.74 for TxRange = 32 and 8.27 for TxRange = 16). Here, we study the effect of hop length on the achievable throughput. In order to mask the effects of other network parameters, we consider a mesh network of $N = 50$ nodes where each node has exactly 4 neighbors. In all simulation runs, we set the number Q of commodity flows to 25. We consider 5 different hop lengths: 1, 3, 5, 7, and 9 hops. For each HopLength, we generate and simulate random sets, each of Q flows whose lengths are all HopLength hops.

When analyzing the effects of the above parameters, we only show the results obtained under NiM; we omit those obtained under CiM as they provide similar results (the results and analysis comparing NiM with CiM are given in Section 7.7). The maximum achievable throughput, shown in graphs in this section, are all per-commodity flow by averaging the total achieved throughput over all the Q flows.

7.2 Throughput Characterization and Analysis under SRP

Fig. 3 shows the effect of transmission range (Figs. 3(a) and 3(d)), node density (Figs. 3(b) and 3(e)), and hop length (Figs. 3(c) and 3(f)) on the achievable throughput under SRP.

7.2.1 The asymptotic bound

Figs. 3(a), 3(b), and 3(c) show that regardless of transmission range, node density, and/or hop length, as the number of antennas increases, the maximum achievable throughput first rises and then flattens out asymptotically. This can be explained as follows. Recall that multiple antennas increase spatial reuse by allowing multiple simultaneous communication sessions in the same vicinity, i.e., nodes can, for example, use their antennas to suppress the undesired signals sent by nearby transmitters, allowing them to receive interference-free signals concurrently with nearby transmitted signals. Therefore, one may conclude that the more antennas a

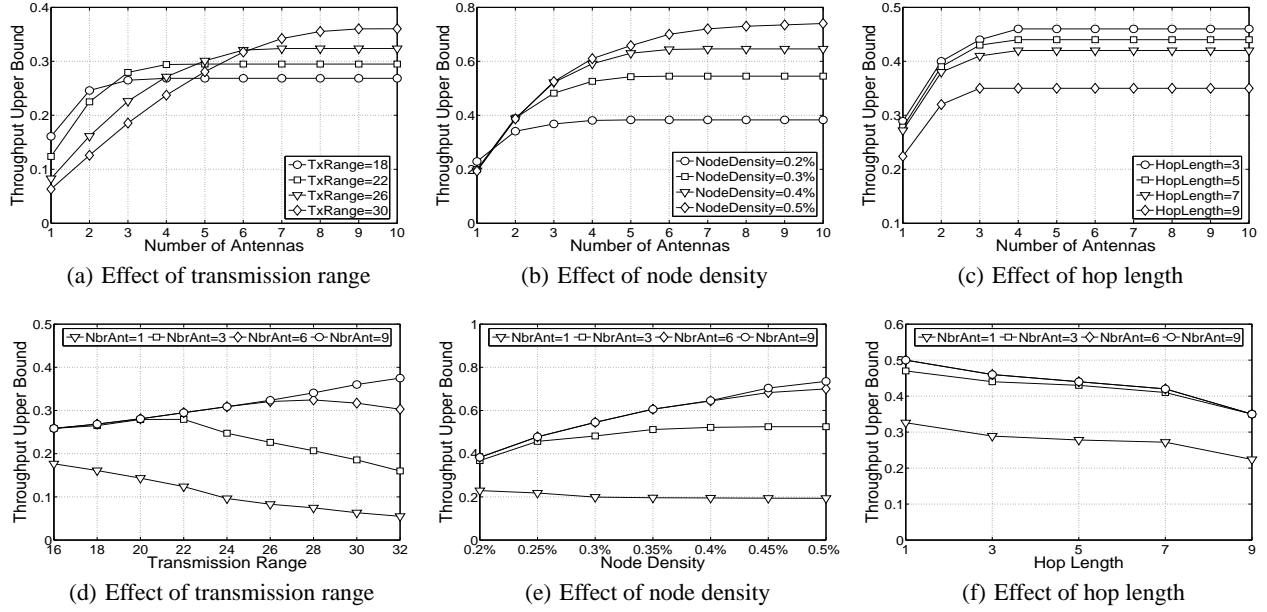

Figure 3: Maximum achievable throughput under SRP.

node has, the more nearby transmitters' signals it can suppress, and hence, the higher throughput the network can achieve. Because, in a given network, each node (e.g., receiver) has a fixed number of interfering nodes (e.g., nearby transmitters), increasing the number of antennas beyond that fixed number of interfering nodes cannot increase the throughput any further since spatial reuse can no longer be increased even if more antennas are added. This is why we see an asymptotic bound on the achievable throughput under SRP.

7.2.2 Effect of transmission ranges—the interference-path diversity tradeoff

Fig. 3(a) shows that for small numbers of antennas, the higher the transmission range, the less the achievable throughput. Conversely, when there are a large number of antennas, the higher the transmission range, the greater the throughput. Also, Fig. 3(d) indicates that as the transmission range increases, the achievable throughput always decreases when each node is equipped with a single antenna. In contrast, the throughput first increases and then decreases when each node is equipped with multiple antennas—for each MIMO size, there exists a transmission range that maximizes the achievable throughput. Note that this optimal transmission range increases as the number of antennas increases. Recall that in networks with long transmission ranges, nodes are likely to have more neighbors. While this provides nodes with higher path diversity, it also provides them with more interference to combat. Hence, when transmission ranges are long, interference dominates if nodes are only equipped with single or small-sized antenna arrays which are not enough to combat the extra interference caused by the long ranges of transmission, thereby achieving less overall throughput. When the number of antennas is large enough, nodes can, however, take advantage of the increased number of paths to find better routes while effectively combating the interference by using their antennas. In this case, the throughput will be increased as more concurrent transmissions are enabled in the same vicinity. This explains why for a large number of antennas, the achievable throughput for long transmission ranges are greater than those for short transmission ranges.

7.2.3 Effect of node density—path diversity at no interference cost

An increase in node density typically yields path diversity as it raises the number of possible end-to-end paths. If the number Q of commodity flows is kept the same as in our case, such an increase in node density does not incur extra interference. When the number of antennas is small (1 or 2, see Fig. 3(b)), path diversity cannot be exploited to increase network throughput. This is because even when presented with more paths to route through, nodes do not have enough antennas to suppress interference at each of those neighboring nodes involved in their multi-path routes. This is why the throughput achievable under small antennas sizes does not depend on node density as shown in Fig. 3(b). When the number of antennas is large, the throughput achievable in dense networks is, however, greater than that in sparse networks due to the multi-path nature arising from higher node degrees; nodes can use their antennas to suppress interference at the nearby nodes involved in multi-path routes while still exploiting path diversity to increase throughput.

For each multiple antenna case, Fig. 3(e) shows that there exists a node density beyond which the achievable network throughput can no longer increase. In other words, for a given set of commodity flows, there is a certain node density threshold beyond which network throughput cannot be increased even if nodes are provided with more paths to route through.

7.2.4 Effect of hop length

Figs. 3(c) and 3(f) indicate that irrespective of the number of antennas, the larger the hop length of end-to-end flows, the less overall network throughput. This is because multi-hop flows with high multiplicity tend to create greater contention for, and hence more interference in, the wireless medium than those with small hop multiplicity. That is, the longer the multi-hop paths, the more flows a node is likely to forward traffic for, and hence, the more contention and interference nodes are likely to deal with.

7.3 Throughput Characterization and Analysis under SMP

Fig. 4 shows the effect of transmission range (4(a) and 4(d)), node density (4(b) and 4(e)), and hop length (Figs. 4(c) and 4(f)) on the maximum achievable throughput under SMP. These figures indicate that regardless of transmission range, node density, and/or hop length, the maximum achievable throughput increases almost linearly as a function of the number of antennas. Unlike SRP, under SMP, the number of signals' streams is proportional to the number of antennas, and hence, so is the overall network throughput, thus making a linear increase in network throughput.

Fig. 4(d) shows that the achievable throughput decreases as the transmission range increases, and this holds regardless of the size of the antenna array. This decline in throughput is due to the fact that the excess of interference resulting from the increase in the transmission range cannot be suppressed under SMP even when nodes are equipped with many antennas; under SMP, all antennas are exploited to increase data rates instead of combating interference. Fig. 4(e) shows that regardless of the number of antennas, the achievable throughput also decreases as the hop length increases. This is because the increase in flows' number of hops introduces extra interference that SMP cannot suppress, either. Unlike the transmission range and hop length cases, throughput does not depend on node density, given a fixed size of antenna array. This is simply because an increase in node density does not incur extra interference.

7.4 Throughput Characterization and Analysis under SRMP

Fig. 5 shows the effect of transmission range (5(a) and 5(d)), node density (5(b) and 5(e)), and hop length (Figs. 5(c) and 5(f)) on the maximum achievable throughput under SRMP. First, note that the achievable throughput under SRMP increases almost linearly as a function of the number of antennas for all combinations of transmission range, node density, and hop length. Recall that SRMP combines both SRP and SMP in that it increases network throughput via spatial reuse and/or spatial multiplexing, whichever provides more overall throughput. As a result, when antennas can no longer be exploited to increase throughput via spatial reuse (i.e., when throughput gained via SRP flattens out), SRMP can still exploit the antennas to increase network throughput further by achieving higher data rates via spatial multiplexing.

7.5 Design Guidelines and Practical Uses

There is an important and useful trend, observed in Fig. 5(d): for each antenna array size, there exists an optimal transmission range that maximizes the achievable throughput under SRMP. For instance, when the number of antennas is 9, the optimal transmission range is about $22m$. A similar trend with respect to node density can also be observed in Fig. 5(d). Note that for every size of antenna array, there is a certain node density threshold beyond which throughput can no longer be increased. For instance, when the number of antennas equals 9, this threshold is about 0.4%.

Therefore, this study can provide guidelines for network designers to determine optimal parameters for wireless MIMO networks; it can be used to determine optimal transmission ranges and node densities of wireless MIMO-equipped networks. MIMO-equipped mesh networks are an example where this study can be very useful. For instance, knowing the size of antenna arrays of mesh nodes, a network designer can use this study to determine the optimal mesh node density (i.e., optimal number of mesh nodes) and the optimal transmission range (i.e., optimal transmission power) that maximize the total network throughput.

7.6 Spatial Reuse vs. Spatial Multiplexing

We now compare the performances of SRP and SMP against each other (SRMP always outperforms the other two). Figs. 6, 7, and 8 show throughput achievable under all MIMO protocols for different values of transmission ranges, node densities, and hop lengths. First, as expected, when nodes are equipped with single antennas, the achievable throughput is identical under all protocols, regardless of transmission ranges, node densities, and/or hop lengths.

Second, when transmission ranges are short (Fig. 6(a)) or node densities are low (Fig. 7(a)), SMP achieves higher network throughput than that achievable under SRP. However, when transmission ranges or node densities are high, the exact opposite trend is observed. In fact, as the transmission range and/or the node density increase, the throughput achievable under SRP increases, whereas that achievable under SMP decreases. That is, in networks with high node densities or transmission ranges, most of the antennas are exploited to increase throughput via spatial reuse instead of spatial multiplexing. It can then be concluded that the antennas are first exploited to increase spatial reuse by suppressing as much interference as possible, and then the remaining antennas, if any left, are exploited to increase data rates via spatial multiplexing.

Hop lengths, on the other hand, do not affect the performances of SRP and SMP vis-a-vis of each other. Fig. 8 shows that the throughput achievable under SMP is higher than that achievable under SRP and remains so despite the hop length. Note, however, that as the hop length increases, the throughput achievable under SMP degrades more significantly than that achievable under SRP. This is because greater hop lengths (i.e., longer routes) typically yield more interference, which limits the throughput obtainable under SMP.

7.7 Non-Cooperative vs. Cooperative Interference Avoidance

Fig. 9 shows the maximum achievable throughput under NiM and CiM. (Note that because NiM and CiM are equivalent under SMP, we only show the results under SRP and SRMP.) As expected, the throughput achievable under the cooperative interference avoidance model is greater than that achievable under the non-cooperative model. When nodes cooperate, redundant interference suppression can be avoided. For example, if a transmitter interferes with a nearby undesired receiver, then both the transmitter and the receiver may each end up using one of its antennas to avoid interference when they do not cooperate. When both the transmitter and the receiver cooperate as under CiM, one of them can use one of its antennas to avoid the interference while the other node can use its antenna to avoid interference with another interfering node, thereby increasing the spatial reuse. Another point worth noting is that as the number of antennas increases, the maximum achievable throughput under both NiM and CiM converge to the same value. As explained earlier, this is because increasing the number of a node's antennas above the number of its interfering nodes can no longer increase the spatial reuse regardless of the interference model. Because network parameters such as transmission range and node density do not affect the obtained comparative results, we only showed one combination.

8. SUMMARY & CONCLUSIONS

This paper models the interference and radio constraints of multi-hop wireless MIMO networks under the three proposed MIMO protocols, SRP, SMP, and SRMP, and the two proposed interference avoidance models, NiM and CiM. An optimal design problem is

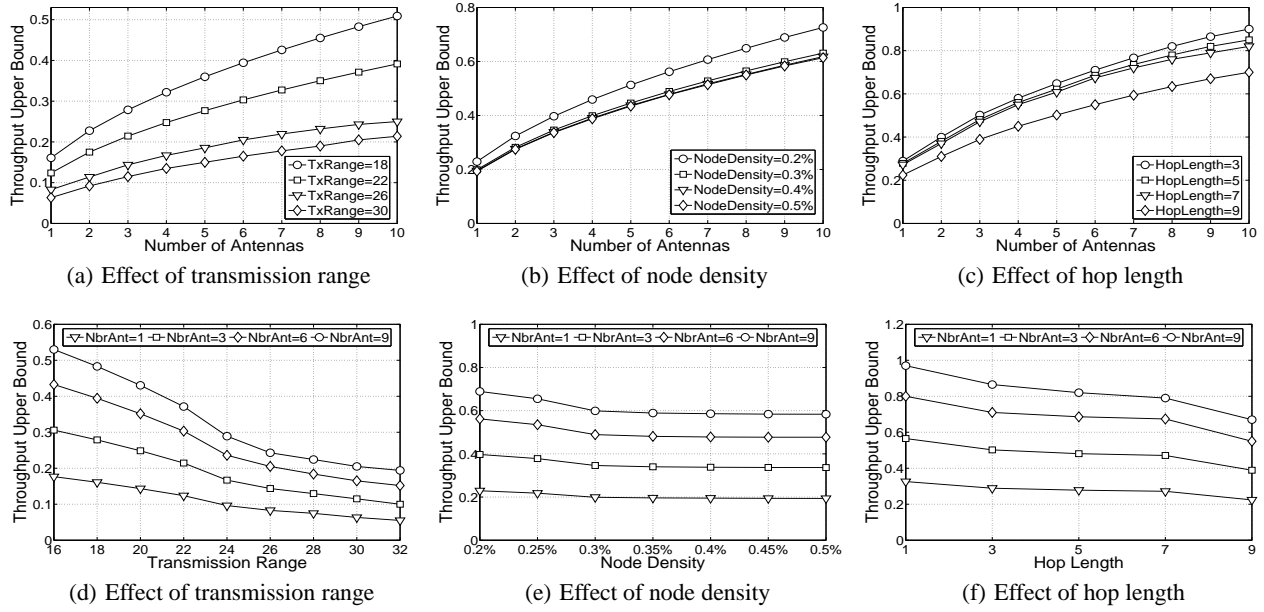

Figure 4: Maximum achievable throughput under SMP.

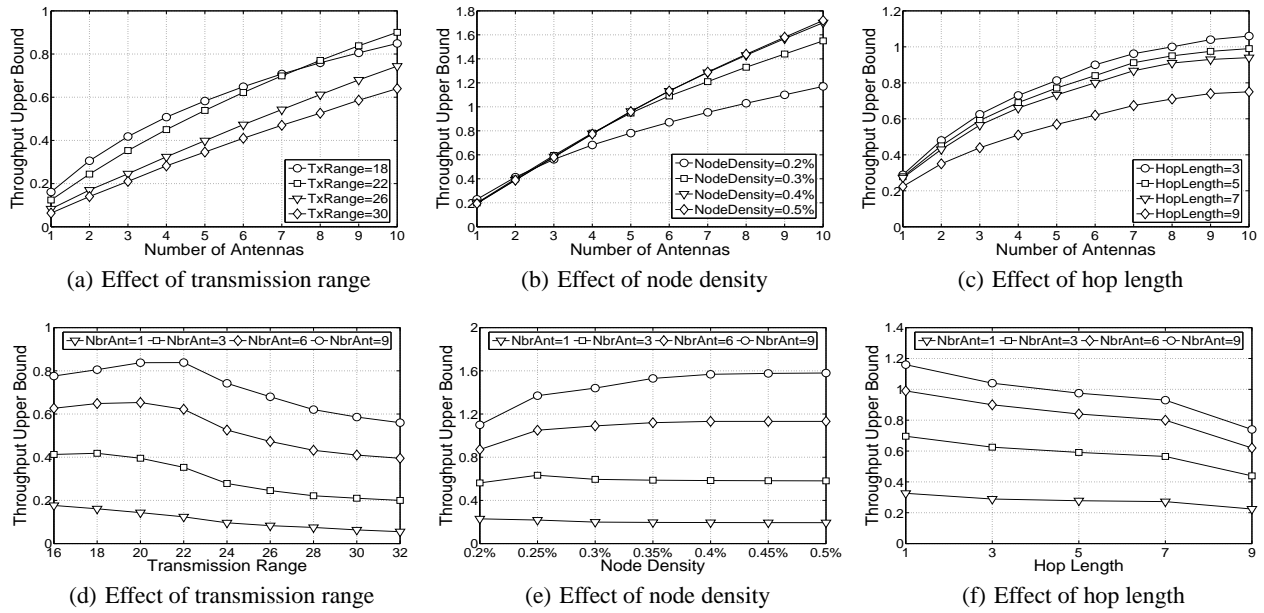

Figure 5: Maximum achievable throughput under SRMP.

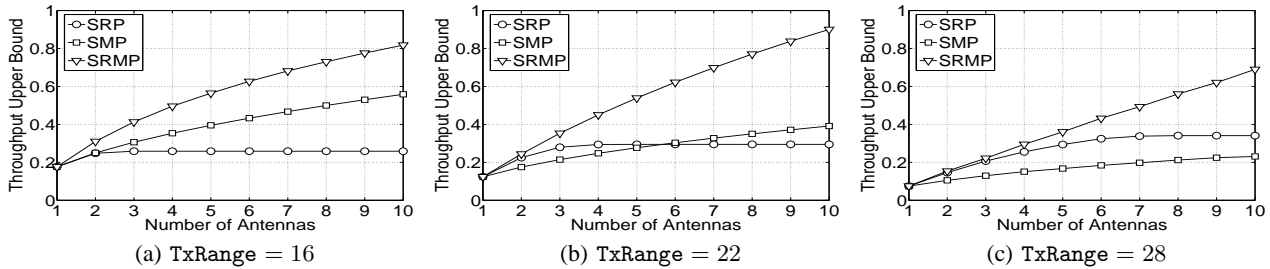

Figure 6: Effect of transmission ranges on the maximum achievable throughput under all MIMO protocols for $N = 50$ and $Q = 25$.

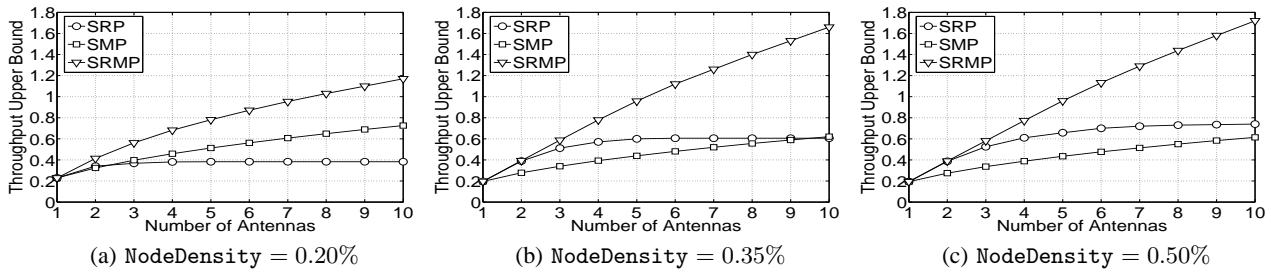

Figure 7: Effect of node densities on the maximum achievable throughput under all MIMO protocols for $T_x\text{Range} = 30$ and $Q = 10$.

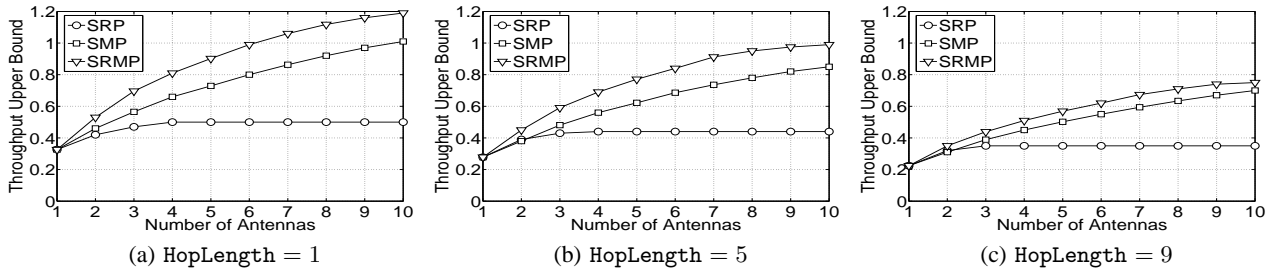

Figure 8: Effect of hop lengths on the maximum achievable throughput under all MIMO protocols for $N = 50$ and $Q = 25$.

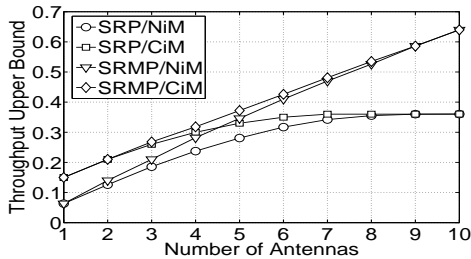

Figure 9: Maximum achievable throughput under SRP and SRMP for $N = 50$, $T_x\text{Range} = 30$, and $Q = 25$: NiM vs. CiM.

formulated as a standard LP whose objective is to maximize the network throughput subject to these constraints. By solving multiple instances of the formulated problem, we were able to characterize and analyze the maximum achievable throughput in multi-hop wireless MIMO networks. We study the effects of several network parameters on the maximum achievable throughput. We also illustrate how these results can be used by network designers to determine the optimal parameters of multi-hop wireless MIMO networks.

9. REFERENCES

- [1] R. Narasimhan, "Spatial multiplexing with transmit antenna and constellation selection for correlated MIMO fading channels," *IEEE Tran. on Signal Processing*, vol. 51, no. 11, Nov. 2003.
- [2] R. S. Blum, "MIMO capacity with interference," *IEEE Journal on Sel. Areas in Comm.*, vol. 21, no. 5, pp. 793–801, June 2003.
- [3] Q. H. Spencer, A. Lee Swindlehurst, and M. Haardt, "Zero-forcing methods for downlink spatial multiplexing in multiuser MIMO channels," *IEEE Tran. on Signal Processing*, vol. 52, no. 2, Feb. 2004.
- [4] S. K. Jayaweera and H. Vincent Poor, "Capacity of multiple antenna systems with both receiver and transmitter channel state information," *IEEE Tran. on Infor. Theory*, vol. 49, no. 10, pp. 2697–2709, Oct. 2003.
- [5] T. Marzetta and B. M. Hochwald, "Capacity of mobile multiple antenna communication link in rayleigh flat fading," *IEEE Tran. on Infor. Theory*, vol. 45, no. 1, pp. 139–157, January 1999.
- [6] J. C. Mundarath, P. Ramanathan, and B. D. Van Veen, "A cross-layer scheme for adaptive antenna array based wireless ad hoc networks in multipath environment," *Wireless Networks (in press)*.
- [7] K. Sundaresan, R. Sivakumar, M. A. Ingram, and T-Y Chang, "A fair medium access control protocol for ad-hoc networks with MIMO links," in *INFOCOM*, 2004.
- [8] A. Nasipuri, S. Ye, J. You, and R. E. Hiromoto, "A MAC protocol for mobile ad hoc networks using directional antennas," in *WCNC*, Sep. 2000.
- [9] L. Bao and J. J. Garcia-Luna-Aceves, "Transmission scheduling in ad hoc networks with directional antennas," in *MOBICOM*, 2002.
- [10] R. R. Choudhury, X. Yang, R. Ramanathan, and N. H. Vaidya, "Using directional antennas for medium access control in ad hoc networks," in *MOBICOM*, 2002.
- [11] T. Korakis, G. Jakllari, and L. Tassiulas, "A MAC protocol for full exploitation of directional antennas in ad-hoc wireless networks," in *MOBIHOC*, 2003.
- [12] S. Yi, Y. Pei, and S. Kalyanaraman, "On the capacity improvement of ad hoc wireless networks using directional antennas," in *MOBIHOC*, 2003.
- [13] P. Gupta and P. R. Kumar, "The capacity of wireless networks," *IEEE Trans. on Infor. Theory*, vol. 2, no. 46, pp. 388–404, March 2000.
- [14] A. U. Bhowe and P. L. Perini, "An overview of smart antenna technology for wireless communications," in *IEEE Aerospace Conference*, March 2001.
- [15] M. Grossglauser and D. N. C. Tse, "Mobility increases the capacity of ad hoc wireless networks," *IEEE/ACM Transactions on Networking*, August 2002.
- [16] P. Kyasanur and N. H. Vaidya, "Capacity of multi-channel wireless networks: impact of number of channels and interfaces," in *MOBICOM*, 2005.
- [17] M. Alicherry, R. Bhatia, and L. Li, "Joint channel assignment and routing for throughput optimization in multi-channel wireless mesh networks," in *MOBICOM*, 2005.
- [18] M. Kodialam and T. Nandagopal, "Characterizing the capacity region in multi-hop multi-channel wireless mesh networks," in *MOBICOM*, 2005.
- [19] B. Hamdaoui and P. Ramanathan, "A cross-layer admission control framework for wireless ad-hoc networks using multiple antennas," *IEEE Transactions on Wireless Communications (in press)*.
- [20] B. Hamdaoui and P. Ramanathan, "Cross-layer optimized conditions for QoS support in multi-hop wireless networks with MIMO links," *IEEE Journal on Selected Areas in Communications*, May 2007.